

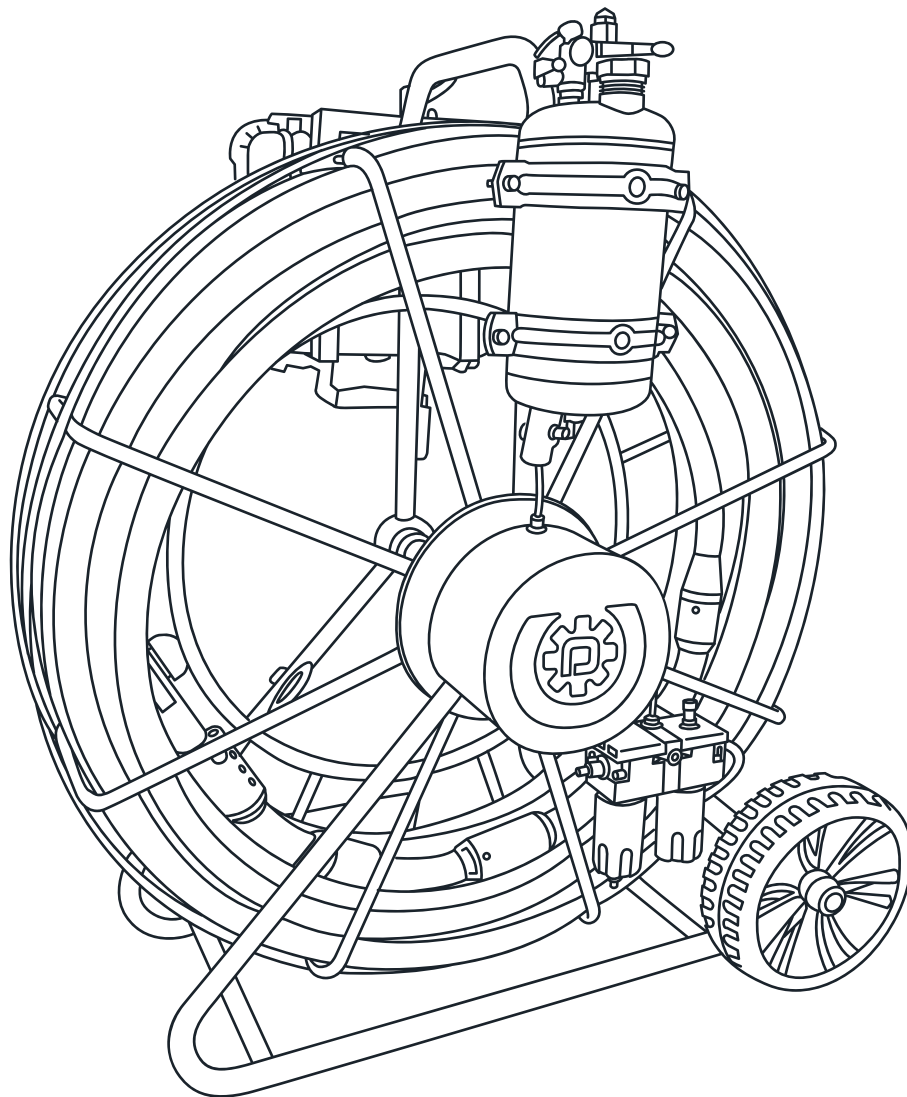

DC SUPER FLEX

Instruction Manual

1.1.2-NA-EN-20260507
50400 >



SCAN ME TO
DISCOVER MORE
INFORMATION
ONLINE



Minicam Inc., 12600 Newburgh Road, Livonia, MI 48150, United States,
Phone: +1 (734) 744 5557, Email: sales@minicaminc.com
www.minicaminc.com

FIND YOUR DEALER

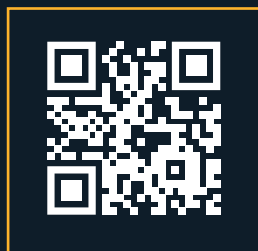

Need support? Scan the QR code
and contact with our recommended Partner



Contents

Instruction manual, DC SUPER FLEX

Table of Contents	2
1.0 Manufacturer	3
1.1 Distributor	3
1.2 Authorised Representative	3
1.3 WEEE Statement	4
2.0 Model type	5
3.0 Specifications	5
4.0 Safety Instructions	5
5.0 Quickguide	6
5.1 Checklist	9
6.0 DC SUPER FLEX	11
7.0 User instructions	13
7.1 Reel (Coiler) Components	18
7.1.1 Water Separator and Oil Lubricator	19
7.1.2 Camera Cleaner Tank	20
7.2 Cutter	21
7.2.1 Installation of Centering Tool Set with Brushes	22
7.2.2 Installation of Centring Tool Set w/ Wheels	23
7.3 Grinder	25
7.3.1 Replacing a Grinder	25
7.4 DC Control Unit 2.0	26
8.0 Service and maintenance	29
8.1 Grinder	29
8.2 Clean Underneath the Cover	29
8.3 Clean Behind Arm/Swivel Support	30
8.4 Clean the Forward/Back Drive	30
8.5 Clean the Rotation Function	31
8.6 Maintaining the Control Unit	31
8.7 Drum Shaft Maintenance	32
8.8 Filter Maintenance	32
8.9 Grabber	33
Service overview	34
9.0 Cutting tools	35
9.1 Tools for Cutting PVC & Liner	35
9.2 Tools for Cutting Concrete	36
9.3 Tools for Cutting Steel	37
9.4 Attachment Instructions for Cutting Tools	38
10.0 Quick Guide for FPV Headset	44
11.0 EU Declaration of Conformity	45

In the event of new product developments, Dancutter reserves the right to change the technical description without advance notice.
Authorised Representative in North America: Minicam Inc., 12600 Newburgh Road, Livonia, MI 48150, United States.
© Copyright 2021 Dancutter A/S. Livøvej 1 A, DK-8800 Viborg, +45 9651 2150, info@dancutter.dk, www.dancutter.com

1.0 Manufacturer

Dancutter A/S

Livøvej 1A
DK-8800 Viborg
Tel: +45 9651 2150
info@dancutter.dk
CVR/VAT no.: 26672678

1.1 Distributor

Minicam Inc.

12600 Newburgh Road
Livonia, MI 48150
United States
Tel: +1 (734) 744 5557
sales@minicaminc.com
www.minicaminc.com

Technical support

If you experience problems with the cutter or if you have any technical questions, please write to sales@minicaminc.com

Order

If you need spare parts or cutting heads, please write to sales@minicaminc.com



Locate a Service Center
minicaminc.com/find-a-service-center

1.2 Authorised Representative

Minicam Inc.

12600 Newburgh Road
Livonia, MI 48150
United States

1.3 WEEE Statement

Under the European Union (“EU”) Directive on Waste Electrical and Electronic Equipment, Directive 2002/96/EC, products of “electrical and electronic equipment” cannot be discarded as municipal waste anymore and manufacturers of covered electronic equipment are obligated to take back such products at the end of their useful life. Dancutter will comply with the product take back requirements at the end of life of Dancutter products that are sold into the EU.

For disposal contact Dancutter or the Dancutter partner in your country.



INFORMATION ON DISPOSAL FOR BUSINESS USERS

Your DC SUPER FLEX is marked with the symbol shown above. It means that used electrical and electronic products should not be disposed of in with general household waste. Contact your Local Council who will advise on the correct recycling procedure to follow.

IN THE EUROPEAN UNION

Please contact Dancutter or you nearest Dancutter Service Centre who will inform you about the take-back of the product. You may be charged for the cost arising from take-back and recycling. Small products (and small amounts) might be taken back by your local collection facilities.

For Spain: Please contact the established collection system of your local authority for take-back of your used product.

COUNTRIES OUTSIDE THE EU

If you wish to dispose of your DC SUPER FLEX, please contact your local authorities and ask for the correct method of disposal.

2.0 Model Type

Identification:

System Type: Mobile cutter unit
Model: DC SUPER FLEX 25 or 50 meters / 82 or 164 ft

3.0 Specifications

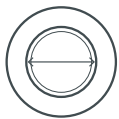

PIPE DIMENSION

Dia. 75 - 150 mm, 3" - 6"



WEIGHT:

25 m: 58 kg / 50 m: 71 kg



STAINLESS - STEEL FRAME

L: 1000 mm / B: 550 mm / H: 1030 mm
L: 39" / B: 22" / H: 41"



GRINDER:

15000 rpm



AIR SUPPLY:

650 l/min



SUPPLY HOSE:

25 or 50 meters, 82 or 164 ft



AIR PRESSURE:

max 10 bar - 145 psi



POWER SUPPLY:

110/240 VAC - LN 



GRINDS, MILLS AND CUTS

Pvc, liner, concrete, iron, cast iron,
stainless steel

4.0 Safety Instructions

- **Grinder Activation:** Only start the grinder when the cutter is securely positioned inside the pipeline
- **Air Connection:** Disconnect the air supply when rolling the cutter back onto the coiler
- **Refilling:** Always disconnect the air connection before refilling the washer fluid
- **Routine Inspection:** Inspect screws, adapters, cutting tools, and other components weekly for wear and damage
Replace or tighten them as necessary
- **Refrigeration Dryer:** Install a refrigeration dryer between the compressor and the cutter system for optimal performance
- **Oil Lubricator Precaution:** If placing the coiler on its side, ensure the oil lubricator glass is removed (Refer to Section 7.1.1)

5.0 Quickguide

Use a compressed air aftercooler (internal or external).

Maximum water content in supply air: 20g/m³ (0.7 ounces/35 cfm).

Always ensure the equipment is properly grounded 

Congratulations on your new DC SUPER FLEX

To maximize the performance and satisfaction from your cutter, it's essential to invest time in learning how to properly operate and maintain it.

Use a compressed air aftercooler (internal or external).
Maximum water content in supply air: 20g/m³ (0.7 ounces/35 cfm).

Forcing a 90° bend

(Applicable for Ø100 mm and above):

- **Align the Cutter:** Turn the cutter in the same direction as the bend
- **Raise the Cutter Arm:** Lift the cutter arm to prepare for the bend
- **Push the Cutter Through:** Gently push the cutter through the bend
- **Lower the Cutter Arm:** Once through, lower the cutter arm
- **Multiple Bends:** If encountering several bends, mark the hose with tape to indicate the correct direction for future reference



AIR REQUIREMENT

650 l/min, (22 cfm)



POWER SUPPLY

110/240 VAC - LN



AIR PRESSURE

max 10 bar - 145 psi

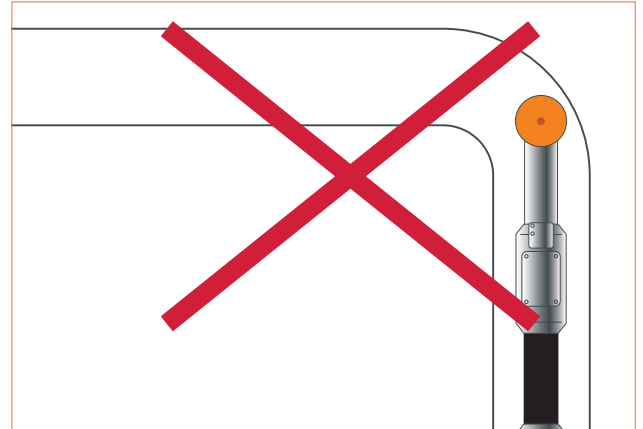
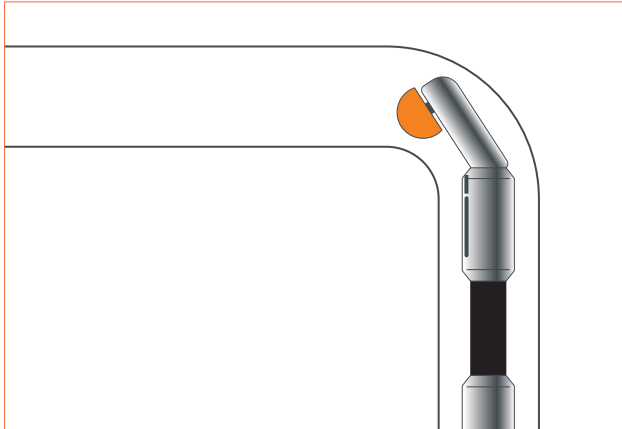

As Needed Maintenance

- **Lubricate the Drum Shaft:** Apply grease to the drum shaft through the grease nipple as needed.
- **Air Filter Maintenance:** Regularly check the air filter (Part No. P57106) in the water separator, ensuring it is kept clean and replaced when necessary

Before use

- **Check Oil Levels:** Ensure the lubricating unit contains sufficient oil
- **Cutter Handling:** Never bend the cutter outside of the pipe
- **Operator Responsibility:** The cutter operator is responsible for safe handling of the cutter both inside and outside the pipe
- **Transport Precaution:** Always keep the forward section closed during transport, whether inside or outside the pipe.
- **Fluid Usage:** Only use pure air and washer fluid with alcohol in the container for camera cleaning.

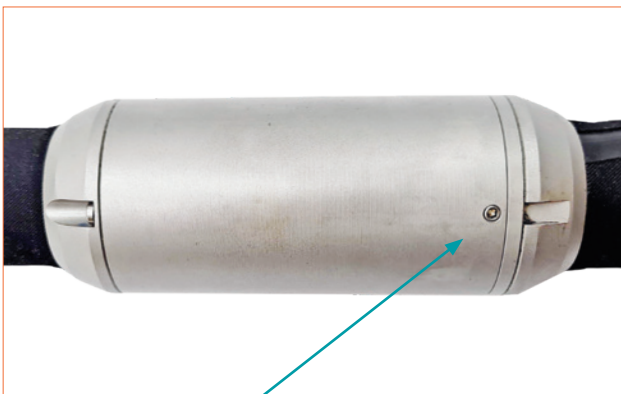

The forward section must **ALWAYS** be closed together during transport in and outside the pipe

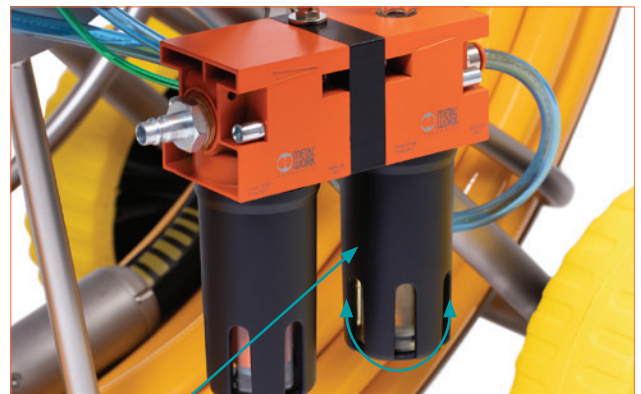

Check the oil

After use

- **Exterior Cleaning:** Clean the outside of the cutter using a water hose (avoid high-pressure cleaners) or compressed air
- **Drive Cleaning:** Use compressed air to clean the forward/back drive. Fully extend the unit and clean the tracks and edges with paper or cloth. If needed, use a small screwdriver to reach into the tracks
- **Arm Cleaning:** Raise the arm fully and clean the hollow space behind the tilt unit with compressed air. Afterward, lubricate the piston with oil and lower the arm
- **Grinder Maintenance:** Remove the grinder and apply oil into the clutch nipple. Then, use a compressed air gun to distribute the oil throughout the engine, ensuring it reaches all areas to prevent water or moisture ingress

Lubricate the grinder

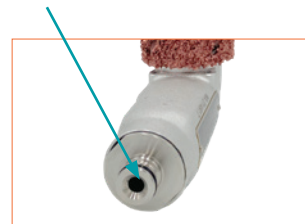

Lubricate the piston

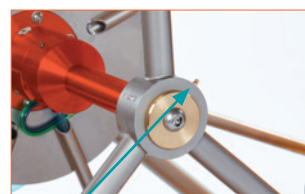
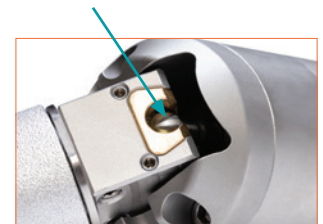

Grease in the grease nipple



Air filter

5.1 Checklist

AIR

1. **Connect Air Supply:** Attach an air supply to the air-processing system with a maximum pressure of 10 bar and a flow rate of 650 l/min.
2. **Use a Refrigeration Dryer:** Ensure a refrigeration dryer is used in conjunction with the compressor.
3. **Moisture Content:** The maximum allowable moisture content in the supply air is 20 g/m³.



OIL

1. **Add Pneumatic Oil:** Ensure the system is filled with the appropriate pneumatic oil.
2. **Oil Inspection:** Check that the oil is clean and its color is clear. Replace the oil if it appears cloudy.
3. **Transport Precaution:** If the system needs to be laid down during transport, unscrew the oil-lubricator glass to prevent oil from entering the cleaner tank.
4. **Oil Flow Adjustment:** After starting the grinder, adjust the screw so that one drop of oil is released every 8–10 seconds.
5. **Oil Film Check:** Once the grinder is running, verify that an oil film is visible flowing through the 10 mm hose.



5.1 Checklist

CAMERA CLEANER

- 1. Cleaning the Camera:** Use either pure air or washer fluid with alcohol to clean the camera. Ensure that the fluid used can evaporate completely from the camera lens.
- 2. Adding Fluid:** Before adding any liquid to the tank, make sure the system/tank is fully depressurized.



RAISING/LOWERING THE ARM

- 1. Regulating Arm Speed:** The speed of the arm can be adjusted by rotating the needle valve. This adjustment is effective only when the arm is in the 'UP' position.
- 2. Lowering the Arm:** The arm will lower under its own weight. Adjust the needle valve so that the arm rises slightly slower than it falls.

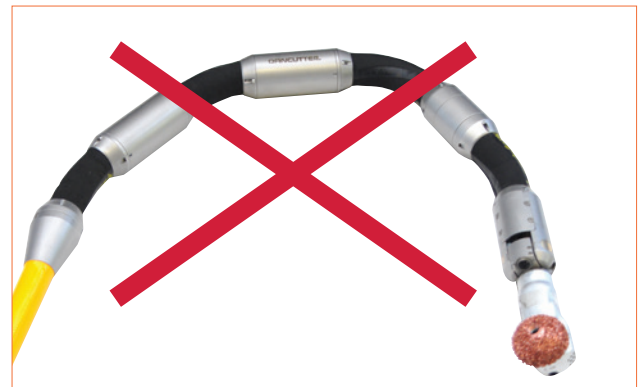
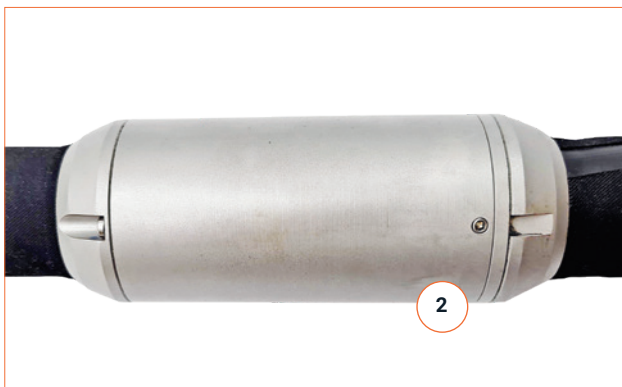

FORWARD/BACK DRIVE

- 1. Operation:** Only use the forward/back drive when actively cutting.
- 2. Transport Position:** The forward/back drive must always be retracted to the closed position during transport, whether inside or outside a tube.

CUTTER

- 1. Bending Limitation:** Do not bend the cutter more than 80°.

6.0 DC SUPER FLEX

Dancutter's Extremely Flexible Cutter

This dynamic cutter can effortlessly move through several 90-degree bends in 100 mm pipes. Whether dealing with straight runs or intricate bends, the DC SUPER FLEX operates with unmatched precision.

The flexibility of the DC SUPER FLEX makes it ideal for re-opening laterals, and its robustness and durability let it easily remove concrete or other hard deposits from pipelines.

When you are cutting, milling, and grinding in pipes ranging from 75 - 150 mm / 3" - 6", regardless of the material - be it PVC, concrete, cast iron, or steel - the DC SUPER FLEX stands out as the perfect tool.



Specifications

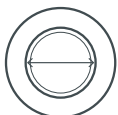

PIPE DIAMETER

Dia. 75 - 150 mm, 3" - 6"



SUPPLY HOSE OPTIONS

25 or 50 metres, 82 or 164 ft



BENDS

45° - 90°



EXPANSION / EXTRACTION

60 mm - 2,4"



ROTATION

360° continuously



GRINDS, MILLS AND CUTS

Pvc, liner, concrete, iron, cast iron, stainless steel

Technical support

If you experience problems with the cutter or if you have any technical questions, please write to sales@minicaminc.com



Highlights

- Extremely flexible in 45° and 90° bends
- 360°-degree continuous rotation
- High-quality stainless-steel alloy
- 12" colour display
- Cuts, grinds, and mills in all materials
- User friendly
- Precise control
- Toolbox and centring tool with brushes are standard accessories

Technical data

- Pipe diameter: 75 - 150 mm / 3" - 6"
- DC SUPER FLEX can be operated by just one person
- The DC SUPER FLEX comes with either a 25 m or a 50 m hose
- The control unit features inlet and outlet sockets for connecting a video recorder, computer, external camera, or FPV headset (optional accessory)
- 12" colour display
- Spray nozzle for cleaning the camera



AIR SUPPLY

650 l/min, 22 cfm



GRINDER

15000 rpm



AIR PRESSURE

Max 10 bar, 145 psi



POWER SUPPLY

110 / 240 VAC - LN 



WEIGHT

25 m: 58 kg, 128 lb/50 M: 71 kg, 156.5 lb



STAINLESS - STEEL FRAME

L: 1000 MM / W: 500 mm / H: 1030 mm
L: 39,37" / W: 19.69" / H: 40.55"

Order

If you need spare parts or cutting heads, please write to sales@minicaminc.com

7.0 User Instructions

- **Positioning the Reel:** Place the reel at the location where the work will be performed.
- **Power Connection:** Connect the accompanying supply cable to a 110/230 VAC power source and plug it into the control unit's outlet.
- **Signal Cable Connection:** Connect the orange signal cable from the reel to the control unit.



Ensure that both tank ball valves are securely closed.



Now, connect the compressed air from the compressor to the reel's combination water separator/oil lubrication unit. (Refer to Section 7.1.1: "3").



For optimal performance, we recommend always having a refrigerated dryer installed on the compressor to minimize moisture content, ensuring it does not exceed 20 g/m³.

Now, feed the cutter into the pipeline.

IMPORTANT:
Test the cutter before inserting it into the pipe!



Next, open the ball valves to supply air to the tank.

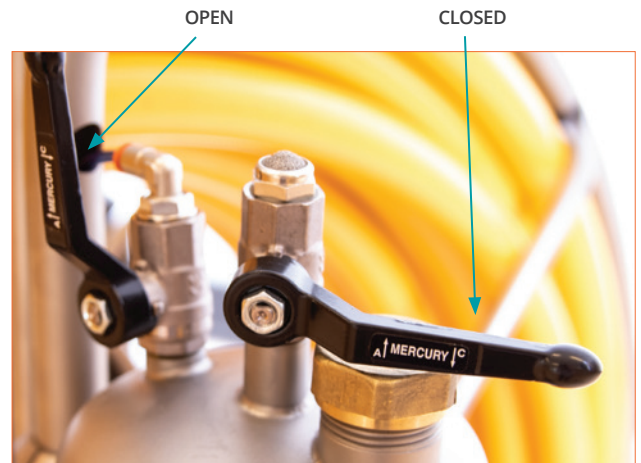

Open the control unit's lid, release the emergency stop button, and turn on the camera light, if needed.



Always ground the Equipment

When using the grinder in dry pipes, static electricity can accumulate. To prevent harm to personnel or damage to sensitive electronic components like the camera, always ground the power connection.

Important:
Test the cutter before inserting it into the pipe!

The Cutter is Now Ready for Use

Feed the Cutter into the Pipeline: If the cutter needs to navigate bends to reach the work site, monitor the process on the control unit. When the cutter reaches a bend, lift and swivel the cutter arm to ease the lead-in. After passing through the bend, remember to re-lower the arm.

Activate the Cutter: Switch on the cutter from the control unit and allow it to run briefly before starting the task. Slowly raise the grinder by pulling the joystick towards you (refer to Section 7.5: "12") so that the cutting head engages with the work area.

When cutting branch line openings, ensure you process a wide area around the opening before the cutting head breaks through the lining or pipe. This minimizes the risk of the cutting head getting stuck. Use the cutter's built-in forward/back drive (refer to Section 7.5: "1") and the rotation function (Section 7.5: "12") to facilitate this process.

Reduce Pressure: Just before the cutting head breaks through the lining or pipe, reduce pressure on the cutter.

FPV Headset: The control unit has built-in WiFi, which can be used with an FPV (First Person View) headset — particularly helpful in bright sunlight.

Extension Cable: If needed, connect an extension cable (available in lengths of 6 and 15 meters) between the coiler and the control unit.

ALWAYS retract the forward/back drive section before moving from one position to another within the pipeline (refer to Section 7.5: "1").

Note: The cutter can navigate through water, but it should not be operated underwater.

After completing a task, make sure to follow the service and maintenance instructions outlined in Section 8.0.



Disconnect the air supply.

REMOVE SUPPLY HOSE



Confirm that the tank is fully depressurized.

POSITION BALL VALVES
AS SHOWN

CLOSED OPEN



After use, place the cutter in the coiler with the grinder in a vertical position, allowing any moisture to drain out of the grinder and into the hose.



Disconnect the two plugs on the back of the control unit and securely screw the caps onto the cables and control unit.



Close the control unit and hang it back on the hose reel.



7.1 Reel (Coiler) Components:

1. **Filling Spout:** For adding washer fluid
2. **Camera Cleaner Tank:** Dedicated tank for camera cleaning fluid
3. **Cover for Sluice and Slip Ring:** Protective cover for the sluice and slip ring mechanism
4. **Air Processing System:** Manages air filtration, lubrication, and drying
5. **Base Plate:** The foundation of the reel (coiler) assembly
6. **Safety relief valve 1/4", set pressure 10 bar:** Protects the machine from high pressure

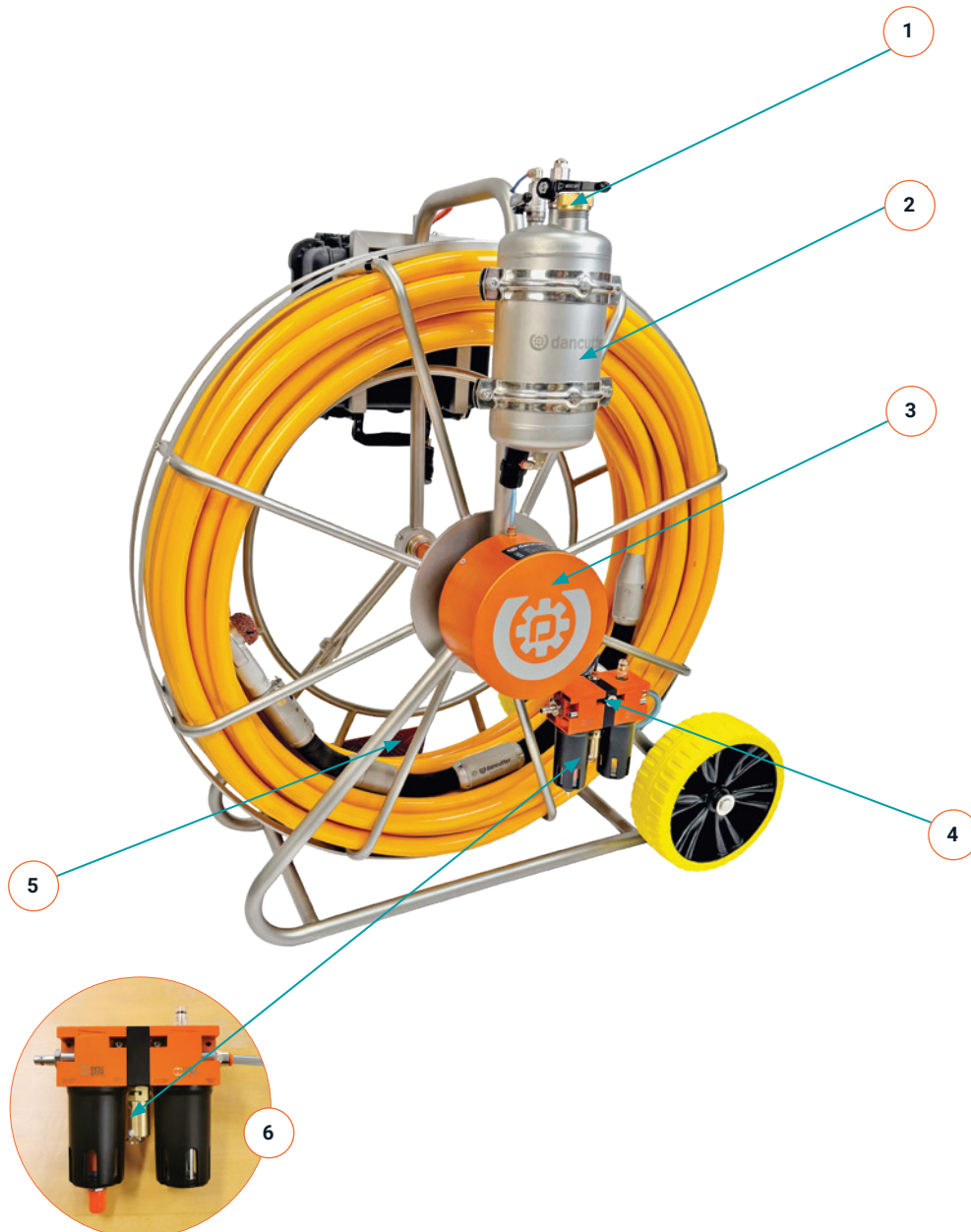

7.1.1 Water Separator and Oil Lubricator

Oil Filling: Always add oil while the system is depressurized before using the cutter. Refill the oil when it is visible at the top of the oil glass (8). Never let the oil run out, as this can damage the cutter and significantly reduce its efficiency.

Pneumatic Oil: Only use pneumatic oil (item no.: DCHY29307).

Air Filter Maintenance: Keep the air filter (item no. P57106) in the water separator (4) clean. Replace it when necessary, as air supply issues may be resolved by replacing the filter. To replace the filter, unscrew the black bottle after depressurizing the cutter.

Oil Lubricator Operation: After the cutter starts, you should see a drop of oil in the liquid indicator (attached to the adjusting screw (5)) every 8–10 seconds. If this does not occur, adjust the top screw.

Transport Precaution: If the unit needs to be laid down during transport, unscrew the oil tank (8) to prevent oil from being mixed into the air processing system, which can cause it to enter the air outlet (1) for the tank.



1. **Air Outlet:** For the camera cleaner tank
2. **Automatic Water Separator:** Equipped with an air filter cartridge (item no. P57106).
3. **Air Inlet: From the compressor**
4. **Automatic Water Separator:** Ensures air is free from moisture
5. **Adjusting Screw:** For the oil lubricator (preset at the factory)
6. **Air Outlet:** For the sluice/cutter
7. **Automatic Oil Lubricator:** Regulates oil flow for lubrication
8. **Oil Tank:** Refill with pneumatic oil (item no.: DCHY29307)
9. **Safety relief valve:** This valve ensures that the machine is not damaged if connected to a compressor delivering a pressure above 10 bar. If this occurs, the valve opens and releases the pressure into the surroundings, which can be clearly heard. In that case, adjust the connected compressor to below 10 bar.

7.1.2 Camera Cleaner Tank

Working in a pipeline can cause dirt to accumulate on the cutter's camera, reducing the quality of the images displayed on the control unit monitor or FPV headset, and making the work more challenging.

The cutter is equipped with a spray nozzle that allows for easy cleaning of the camera during operation.

IMPORTANT REMINDER:

Add Washer Fluid: Before using the cutter, ensure washer fluid is added if you plan to use fluid for cleaning the camera.

Dry Air Option: Alternatively, you can opt to clean the camera using just dry air.

Task Setup:

For dry tasks, empty the tank.
For wet tasks, fill the tank.

IMPORTANT!

Air Disconnection & Depressurization: Always disconnect the supply air from the air processing system and depressurize the tank before adding washer fluid.

Correct Ball Valve Positioning: It is crucial to properly position the two ball valves for the camera cleaner tank to ensure safe and efficient operation.

The illustration below demonstrates the correct positioning of the two ball valves for both operating and adding washer fluid.

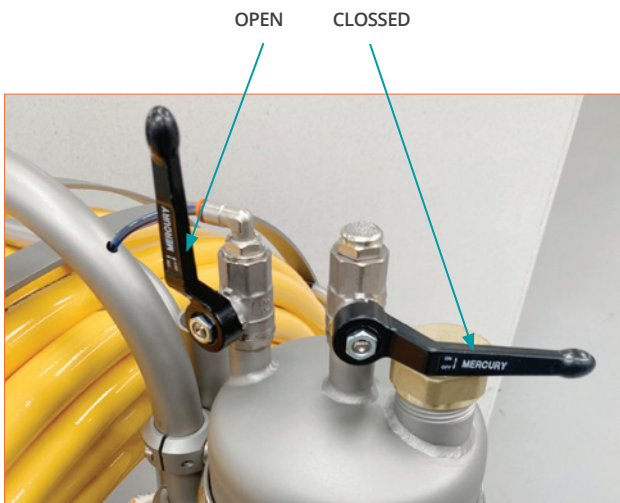

Position for Operating the Cutter

Before beginning work, ensure the two ball valves are set correctly:

Open the air supply to the tank.

Close the ventilation to prevent air from escaping.

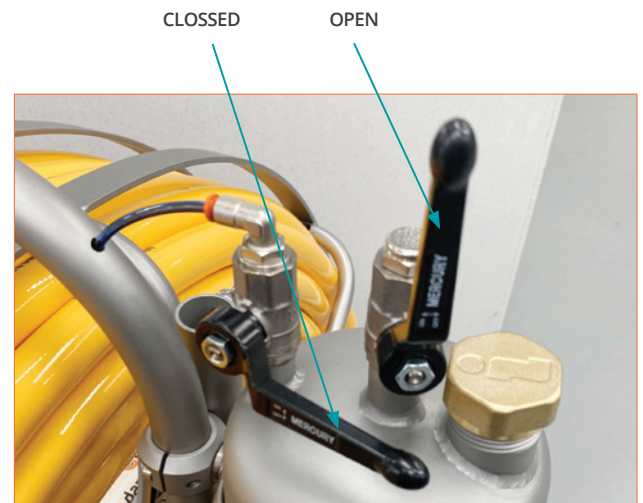

Position for Adding Washer Fluid

Set the ball valves to the opposite positions:

Close the valve that supplies compressed air to the tank.

Open the valve to vent the tank.

Ensure the tank is completely depressurized before removing the brass lid (using a suitable tool). Once depressurized, add the washer fluid.

7.2 Cutter

1. Camera
2. Camera spray nozzle
3. Forward/back drive section
4. Screws for grinder attachment
5. Rotation section: 360° rotation
6. Complete intermidiate hose

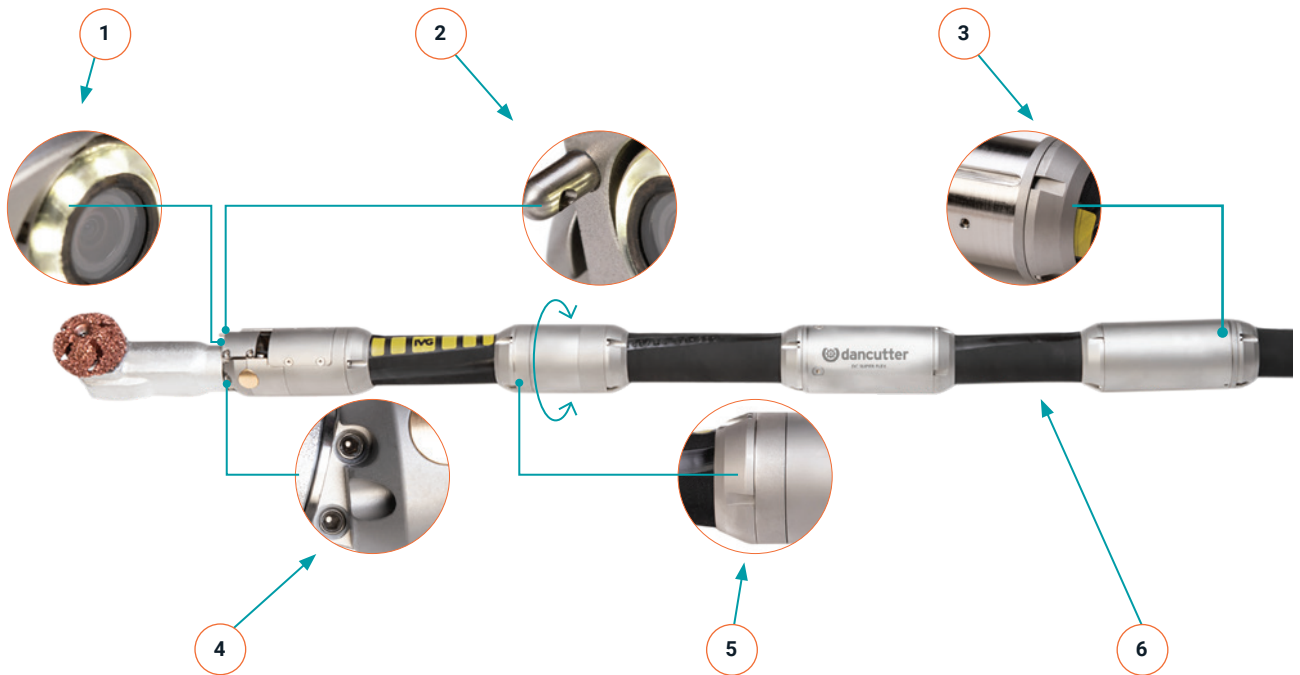

Specifications

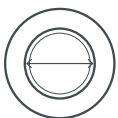

PIPE DIMENSION

Dia. 75 - 150 mm, 3" - 6"



SUPPLY HOSE

25 or 50 metres, 82 or 164 ft



FLEXIBLE

45° - 90°



FOR- /BACKWARDS

60 mm - 2,4"



ROTATION

360° continuously



GRINDS, MILLS AND CUTS

Pvc, liner, concrete, iron, cast iron, stainless steel

7.2.1 Installation of Centering Tool Set with Brushes

When installing the centering tool set with brushes, ensure the hollow/recess on each half-globe is always facing towards the grinder. The spotfacings on the half-globes are tapped in this direction for proper alignment.

This is especially critical for the unit mounted at the rotation point (refer to Section 8.4), as incorrect installation can cause tightening, which will hinder the smooth rotation of the grinder.



Ensure the spotfacings are positioned facing forwards.



Tighten the centering kit so that the raised areas on the trailing edge of each section of the cutter align seamlessly with the individual blocks.



When operating in downpipes, insert the supplied brushes into the holes on the individual blocks in the centering tool set.

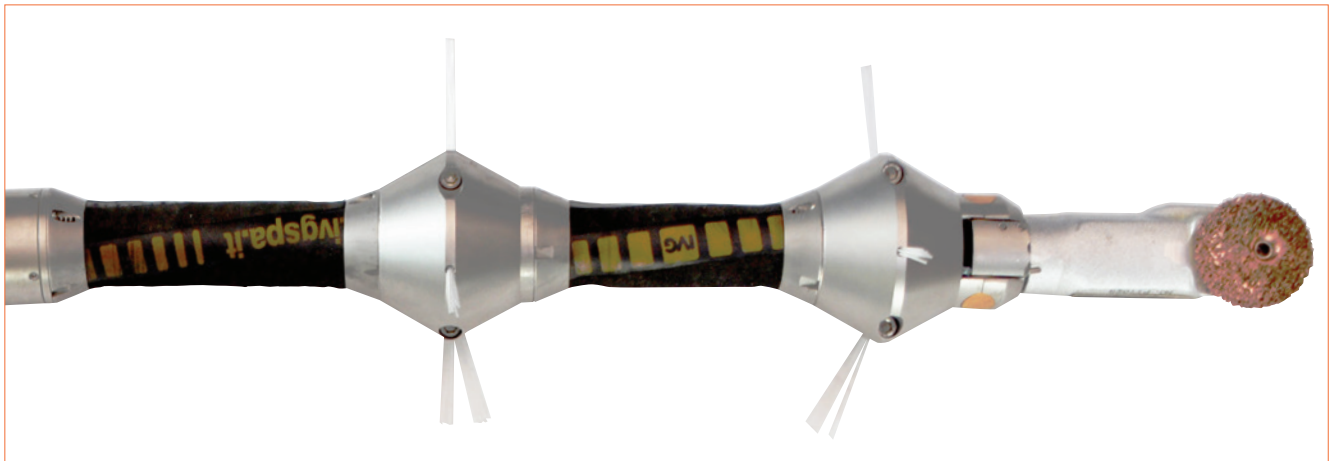

7.2.2 Installation of Centring Tool Set w/ Wheels

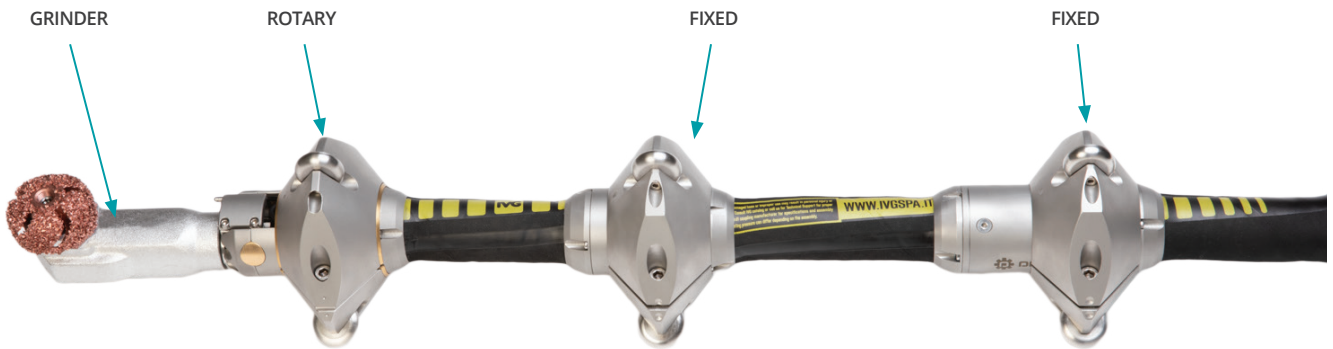

IMPORTANT!
Remove the cover before installing the centring tool set.

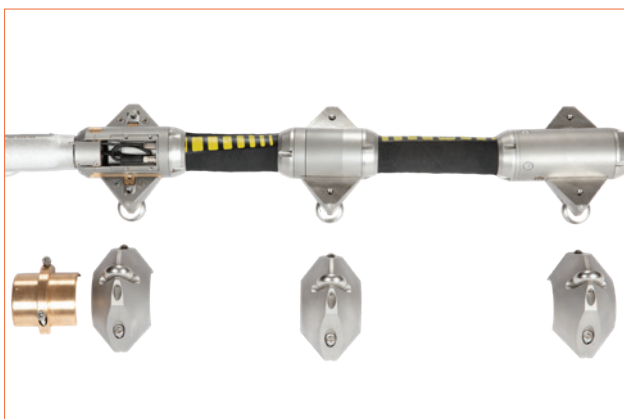

Place the cutter underneath the three centering rings, ensuring the rotary centering ring is flush with the grinder.

Position the middle centering ring so that its internal clearance allows the slip ring system to rotate freely.



Spotfacing Alignment: Each part of the centering tool set has a spotfacing on its periphery.

It is **VERY IMPORTANT** that the spotfacings are aligned one on top of the other during installation.

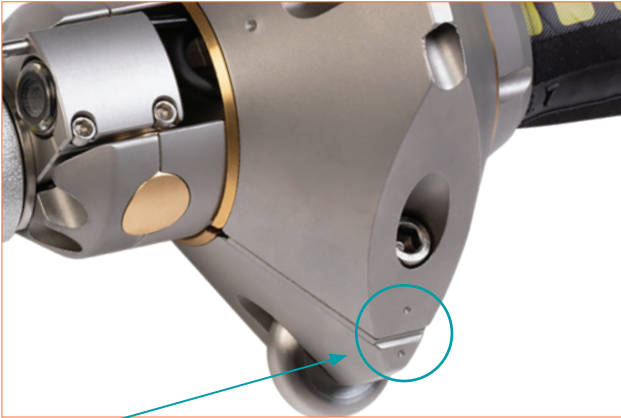

Align the Spotfacings: Ensure the spotfacings on the centering tool set are positioned one on top of the other.

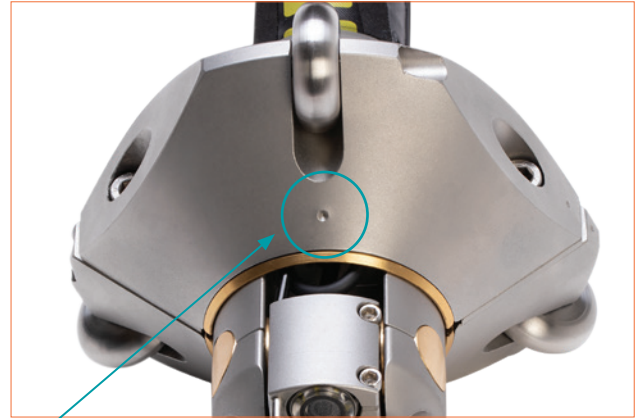

Spotfacing Indicator on Centering Rings: Each centering ring has a spotfacing to indicate which side should face the grinder. Make sure this is correctly aligned during installation.

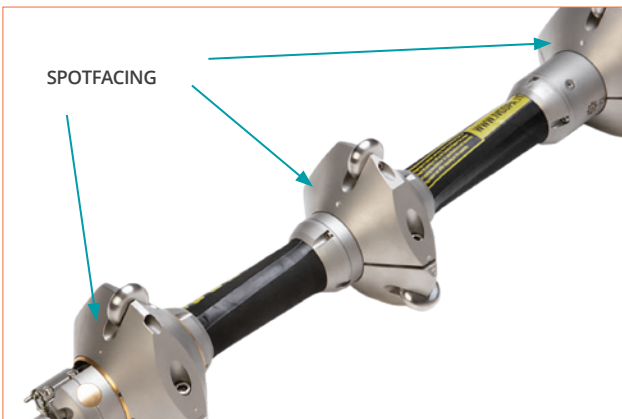

Position the spotfacings so that they face forwards.



7.3 Grinder

The cutter is equipped with a DC SUPER FLEX Angle Grinder (SFAG) as standard. Dancutter offers additional grinder options for different applications, which are listed below:



DC SUPER FLEX Angle Grinder (Standard fitted)
 A powerful motor that covers most tasks for Ø75 - 150 mm pipes.



DC SUPER FLEX Straight Grinder (Additional equipment)
 Suitable for Ø75 - 150 mm pipes.

7.3.1 Replacing the Grinder

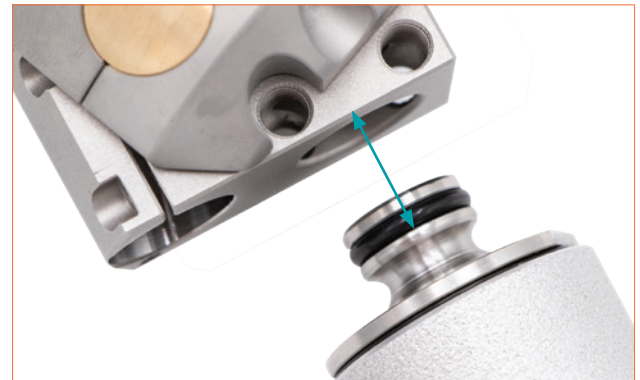
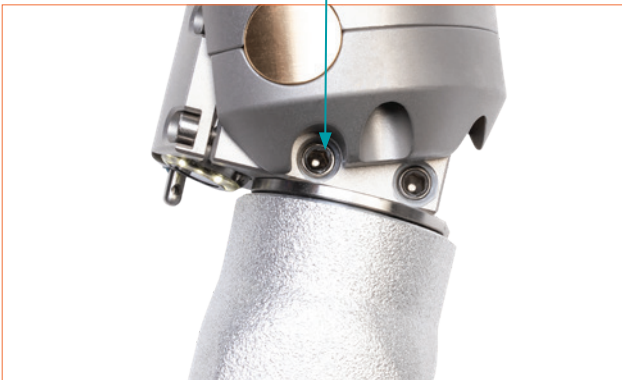

1. **Loosen the Screws:** Use a hex key to loosen the three screws securing the grinder
2. **Remove the Grinder:** Once the screws are loosened, the grinder can be pulled out
3. **Install the New Grinder:** Install a new grinder by following the reverse order of removal. Before inserting the grinder, moisten the O-ring with oil. If the O-ring is cracked or damaged, replace it. Visually inspect the O-ring before installation
4. **Lubricate the Grinder:** Add a small amount of pneumatic oil to the detached grinder and use an air gun to spread the oil inside it thoroughly. Then, return the grinder to the toolbox.

7.4 DC Control Unit 2.0

The DC Control Unit 2.0 allows you to control both the DC SUPER FLEX and DC MAXI FLEX cutters. To power it up, attach the cable from the coiler and the power cable to the control unit.

Note: The control unit is not waterproof when open, so take care to protect it from water.

BUTTON / JOYSTICK FUNCTIONS:

- 1. Stop:**
Emergency stop for the system
- 2. Grinder:**
Controls the grinder's operation
- 3. Left Joystick:**
Controls cutter movement and positioning
- 4. Camera Clean:**
Activates the camera cleaning function
- 5. External Video Source:**
Switch to an external video input source
- 6. Video In:** Connects video input
- 7. Video Out:** Connects video output
- 8. Reverse Forward/Backward:** Controls the cutter's forward and back ward movement in reverse
- 9. USB Memory Stick/FPV Headset Charge:**
Slot for USB memory or charging the FPV headset
- 10. Light:**
Turns the camera light on or off
- 11. Reverse Rotation:**
Controls reverse rotation of the cutter
- 12. Rotation Speed:**
Adjusts the rotation speed of the cutter
- 13. Playback Control Panel:**
Manages video playback
- 14. Start Recording:**
Begins recording video from the camera
- 15. Right Joystick:**
Controls additional cutter movements and adjustments
- 16. Stop Recording:**
Ends the video recording session

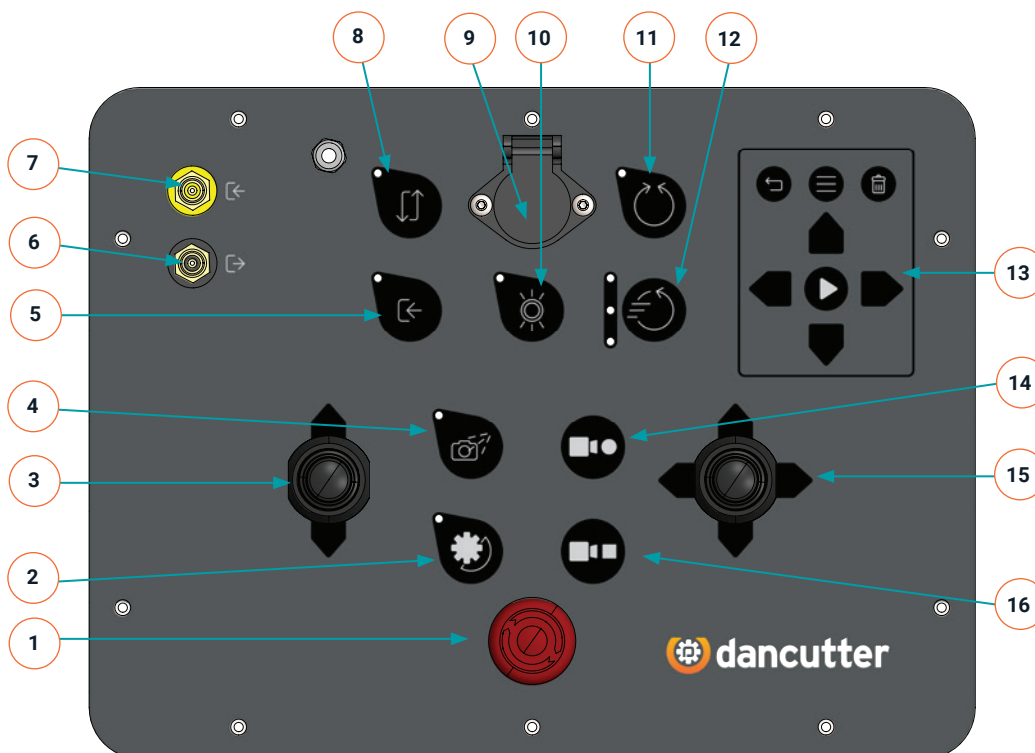

Specifications



DISPLAY

12"



WEIGHT

7 kg, 15.4 lb



LENGHT

L: 350 mm / 39"

B: 300 mm / 22"

H: 150 mm / 41"



GRINDER: Press this button to start or stop the grinder. The grinder is active when the green light is illuminated.



STOP: Press this button to halt all cutter movements. To resume normal operation, rotate the button.
Note: After releasing the stop button, the grinder will remain inactive until manually restarted.



CAMERA CLEAN: Press briefly to dispense a small amount of sprinkler fluid or air to clean the camera lens. Press and hold the button for 3 seconds to activate the sprinkler continuously until the button is pressed again. The green light will indicate that the camera cleaning function is active.
LIGHT: Press to turn the camera light on or off. The light is active when the green indicator is illuminated.



LIGHT: Press to turn the camera light on and off. The camera light is on when the green light is on.



LEFT JOYSTICK: Use this joystick to control the cutter's forward and backward movement. The current extension of the forward/backward section is displayed on the bar at the bottom of the screen.



RIGHT JOYSTICK: Use the up/down motion to raise and lower the grinder. Use the left/right motion to rotate the cutter.



ROTATION SPEED: Press this button to adjust the cutter's rotation speed across three levels:
1 light on: low speed. **2 lights on:** medium speed. **3 lights on:** high speed.



START RECORDING: Press to begin recording a video. Ensure a USB stick is inserted into the appropriate USB socket, as the recording will be saved directly to it. The **"REC"** indicator will blink in the lower left corner of the screen when recording is active.



STOP RECORDING: Press to stop the video recording.



PLAY (Snapshot Function): In normal mode, press the PLAY button to take a snapshot of the screen, which will be saved to the USB stick. The screen will briefly display **"SNAP"** to confirm the snapshot.



EXTERNAL VIDEO SOURCE: Press to switch between video feeds:

When the light is off, the video feed comes from the cutter's built-in camera.
When the light is on, the video feed comes from an external video source connected to the **"video in"** socket.
Note: The settings for **"reverse forward/backward"** and **"reverse rotation"** are saved independently for each video source, and will revert to their saved states when switching back to the original video source.



← **VIDEO IN:** Use this port to display video from an external source on the control unit's screen.



→ **VIDEO OUT:** Use this port to display the cutter's video feed on another external screen.



REVERSE FORWARD/BACKWARD: Press this button to reverse the cutter's forward/backward movement when controlling it via the joystick. This feature is especially useful when an external camera is providing a different viewing angle of the cutter. The light will be illuminated when reverse rotation is active, indicating that rotation direction is inverted.



REVERSE ROTATION: Press this button to reverse the direction of the cutter's rotation when using the joystick. This feature helps make the controls more intuitive when viewing the cutter from an external camera.



PLAYBACK CONTROL PANEL: This panel is used to control the playback function. You can playback videos and snapshots recorded with the control unit.



MENU: Press this button to enter the playback menu.



RETURN: Press to go back or exit the playback menu.



DELETE: Press to delete video recordings or snapshots..



PLAY: Press to play or pause videos, or to enter menus and folders.



ARROWS: Use the arrow buttons to navigate through menus, folders, and files.

8.0 Service and Maintenance

8.1 Grinder

- **Grinder Cleaning:** Clean the grinder using either water or compressed air.
- **Greasing the Grinder:** Unscrew the hex screw at the end of the grinder (GRS). Add a drop of grease into the screw hole. Re-attach the screw. Perform this once a week or as needed.
- **Post-Operation Care:** If the grinder has been used in a damp environment or will remain idle for a long period, remove the grinder. Drip oil into the coupling nipple and use an air gun to evenly distribute the oil throughout the motor. This process will help displace any water or moisture to prevent corrosion.

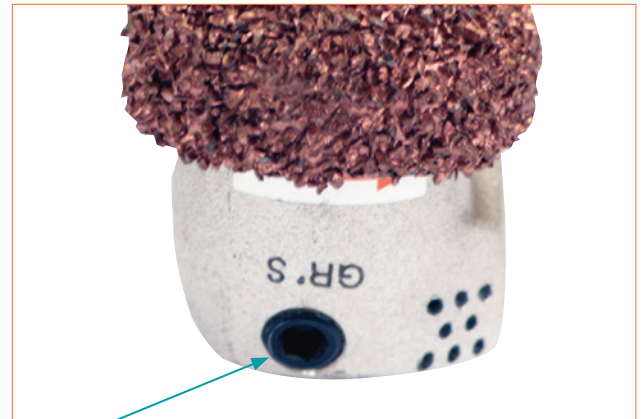

GREASE (F85001)

8.2 Clean underneath cover

- **Compressed Air Cleaning:** Use compressed air to clean underneath the cover next to the camera outlet.
- **Dismantle the Cover:** If necessary, remove the cover to access the area for thorough cleaning.

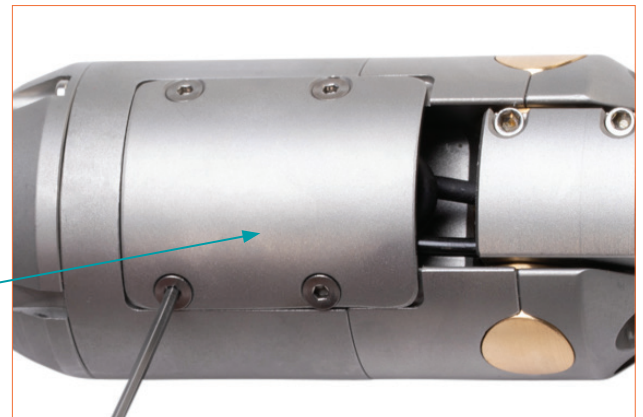

DISMANTLE THE COVER

8.3 Clean Behind Arm/Swivel Support

- **Raise the Arm:** Fully raise the arm to access the space behind the swivel support.
- **Clean:** Use compressed air to clean the space thoroughly behind the swivel support.
- **Lubricate:** After cleaning, apply oil to the piston and swivel support, then lower the arm back into place.

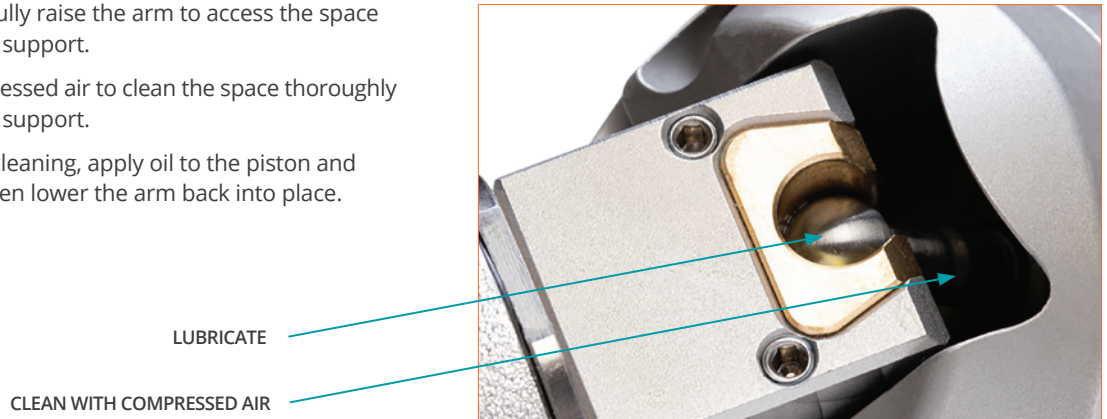

8.4 Clean the Forward/Back Drive

- **Compressed Air Cleaning:** Clean the forward/back drive unit using compressed air. Fully extend the unit and ensure the tracks and edges are thoroughly cleaned.
- **Avoid Lubrication:** After cleaning, do not lubricate the forward/back drive unit with oil or grease. Doing so can cause dirt and grime to stick, hindering its movement.
- **Prevent Water Ingress:** If the cutter's forward/back drive gets scratched or becomes leaky, water can penetrate from the outside. To avoid this, always keep the forward/back drive section closed when moving the cutter forward or backward in the pipeline.

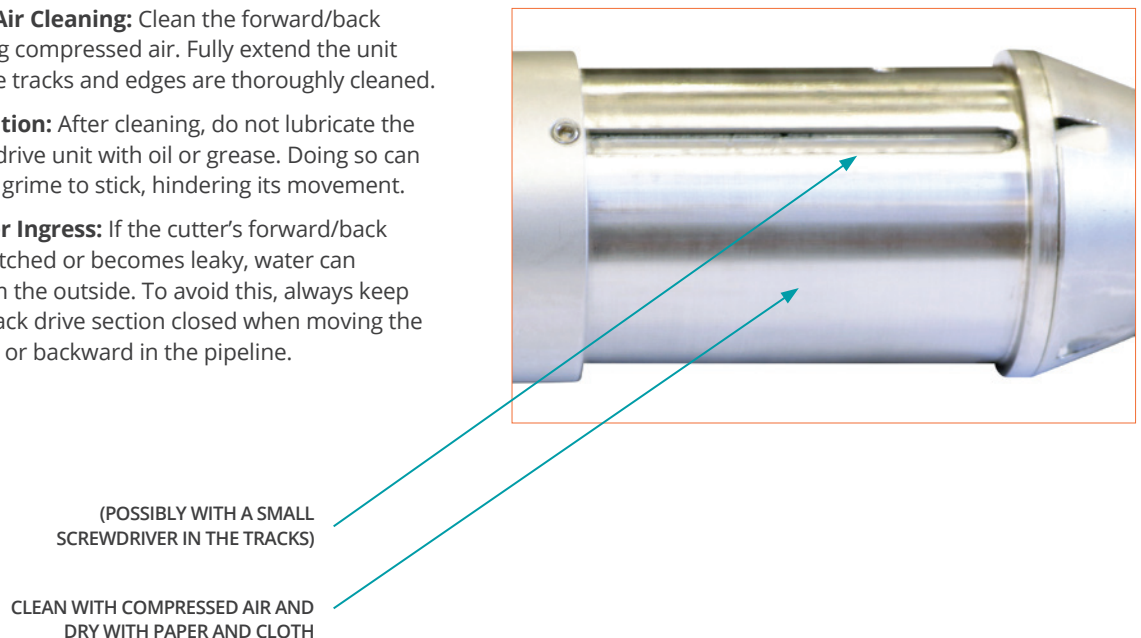

8.5 Clean the Rotation Function

- **Remove Sand and Dirt:** Use compressed air to blow out any sand or dirt from the thin groove around the rotation function.
- **Prevent Overloading:** Operating the rotation function with dirt in the groove can unnecessarily overload the rotation motor, potentially leading to motor defects or damage to the control unit components.

CLEAN THE GROOVE WITH
COMPRESSED AIR

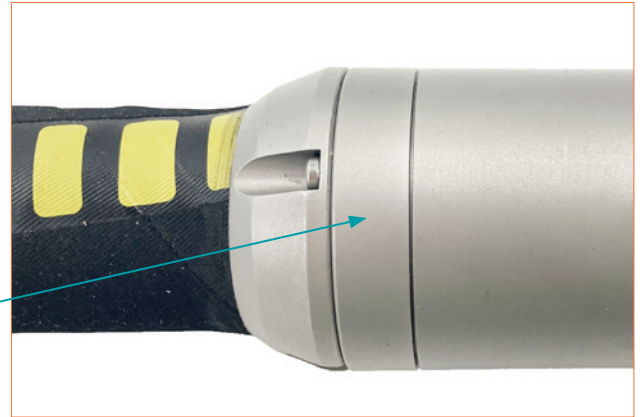

8.6 Maintaining the Control Unit

- **Keep Dry:** The control unit is not watertight, so avoid exposing it to water or moisture. After use, close the unit and hang it on the hose reel to protect the screen and switches.
- **Protect Outlets:** Always replace the caps on the cables and control unit after use to safeguard the power outlets.
- **Proper Storage:** After use, always hang the control unit in its designated place to ensure longevity and protection.

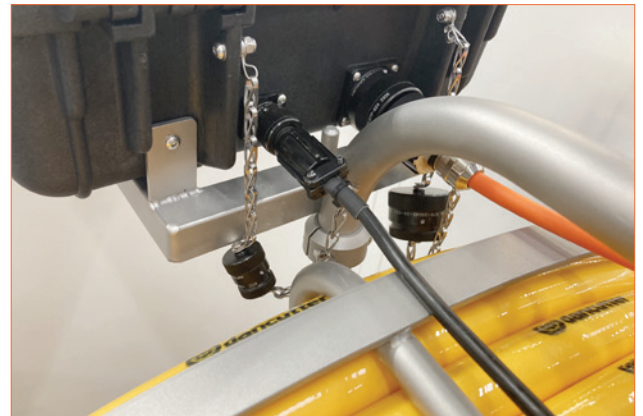

8.7 Drum Shaft Maintenance

- **Lubrication:** Apply grease to the drum shaft through the grease nipple.
- **Frequency:** If the cutter is used daily, lubricate the drum shaft approximately twice a year.

GREASE

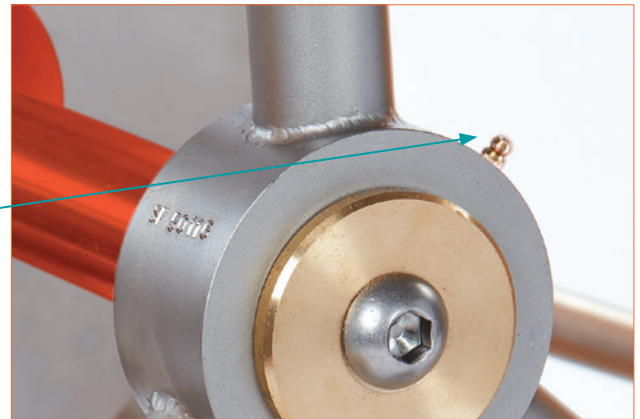

8.8 Filter Maintenance

- **Filter Cleaning:** Clean the filter insert (**Part No. F80546**) as needed to ensure optimal performance.

FILTER

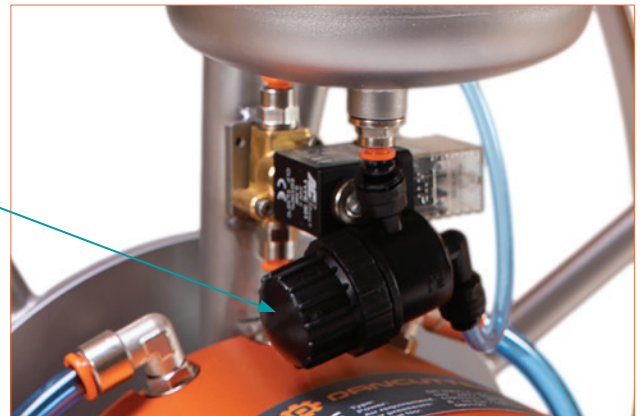

8.9 Grabber

- We recommend the following steps to service and maintain the grabber after each use:

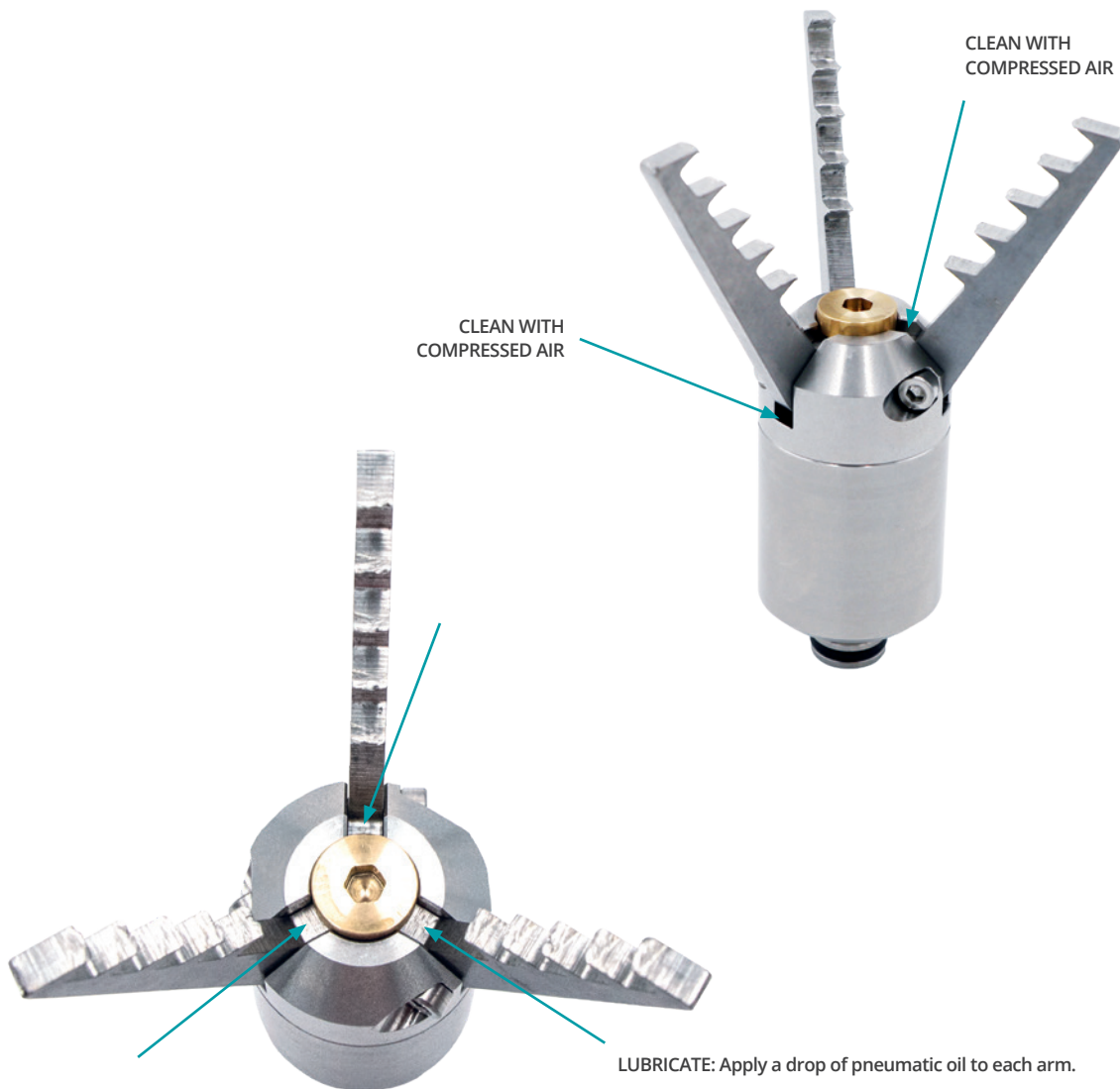

LUBRICATE: Apply a drop of pneumatic oil to each arm.

MOVE THE ARMS: Move the arms up and down a few times to ensure the oil is evenly distributed and the arms function smoothly.

8.9 Service Overview

SERVICE OVERVIEW			
Part - components - service	Daily	Weekly	Other
Clean the cutter	x		
Check pneumatic oil. See 7.1.1 (5). Add oil as needed. See 7.1.1 (8)	x		
Clean and lubricate the piston and swivel support unit insert. See 8.3	x		
Lubricate the Grinder. See 8.1	x	x	
Visually inspect the cutter. Inspect screws, adapter, cutting tools, etc., for wear and damage. Replace or tighten as needed	x		
Lubricate with grease in the grease nipple. See 8.7 (once or twice a year)			As required
Add washer fluid. See 7.1.2			As required
Replace air filter. See 7.1.1 (4)			As required
Clean the grabber	x		
Apply a drop of pneumatic oil to each arm of the grabber. Move the arms up and down a couple of times to ensure even distribution of the oil and smooth operation.	x		

9.0 Cutting Tools

9.1 Tools for Cutting PVC & Liner

The standard cutter is equipped with the DC SUPER FLEX Angle Grinder, which directs air forward to clear dust away from the camera. To replace the cutting tool, use the supplied Allen key. It may be necessary to clean the bolt in the grinding motor before securing the cone milling tool.

Dancutter recommends the following cutter heads for re-opening laterals:



DK2020-18



DK2629-16



DK3015-16



DK3713-16



DK4623-16



DJ1938-14

Special tools for DK3713-16



Special tool DK3713-V - DK3713-B

9.2 Tools for Cutting CONCRETE

Dancutter recommends the following diamond heads for cutting in concrete



DKA1022



DD4623



DD3015

9.3 Tools for Cutting STEEL

Dancutter recommends using the following diamond heads for cutting in iron/steel



DD9008



DD9023

9.4 Attachment Instructions for Cutting Tools

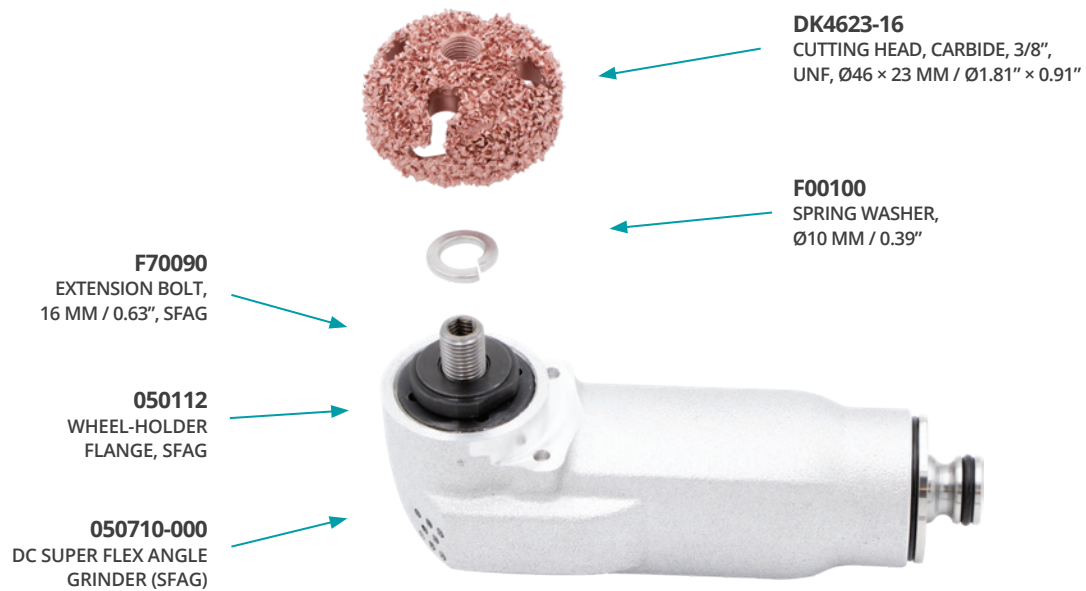

9.4 Attachment Instructions for Cutting Tools

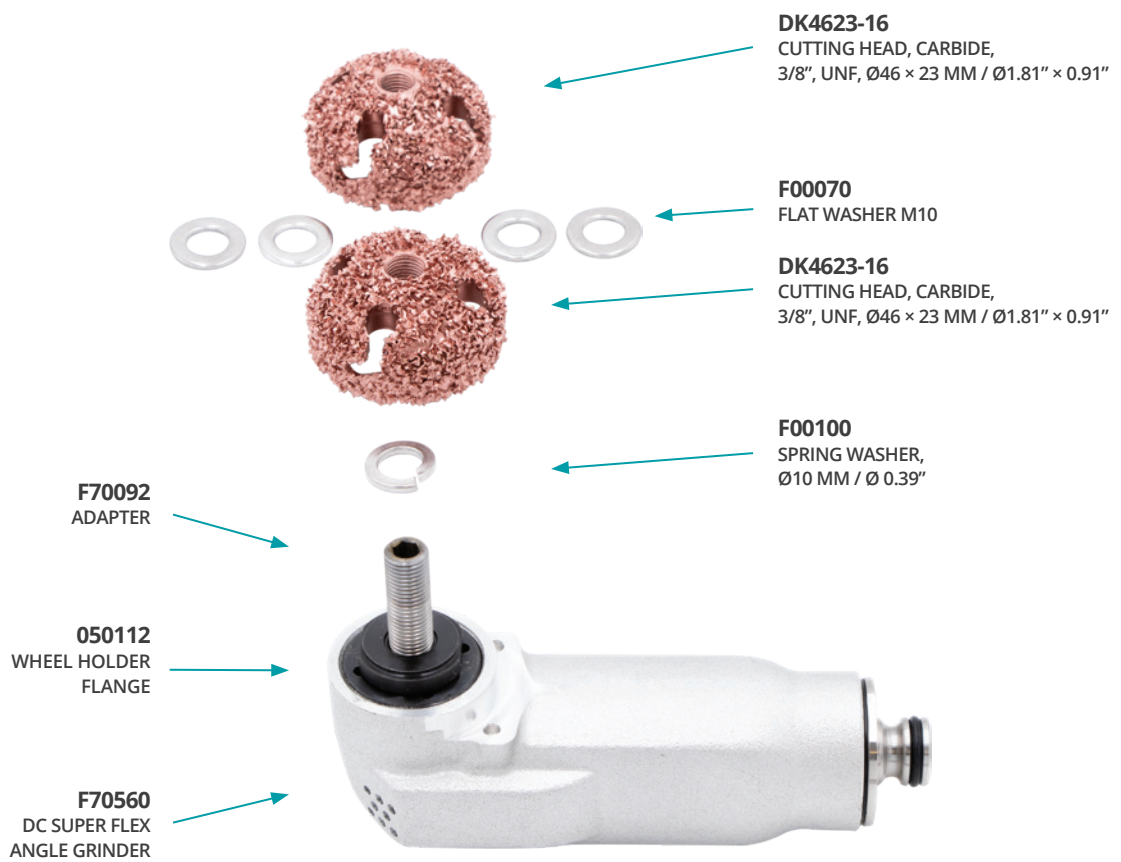

9.4 Attachment Instructions for Cutting Tools

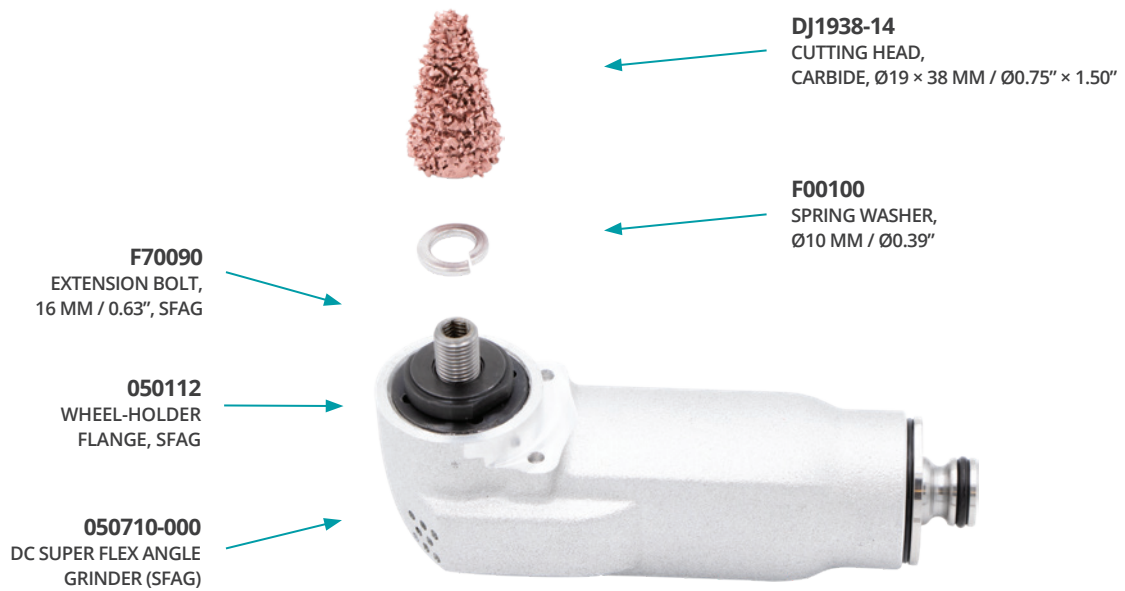

9.4 Attachment Instructions for Cutting Tools

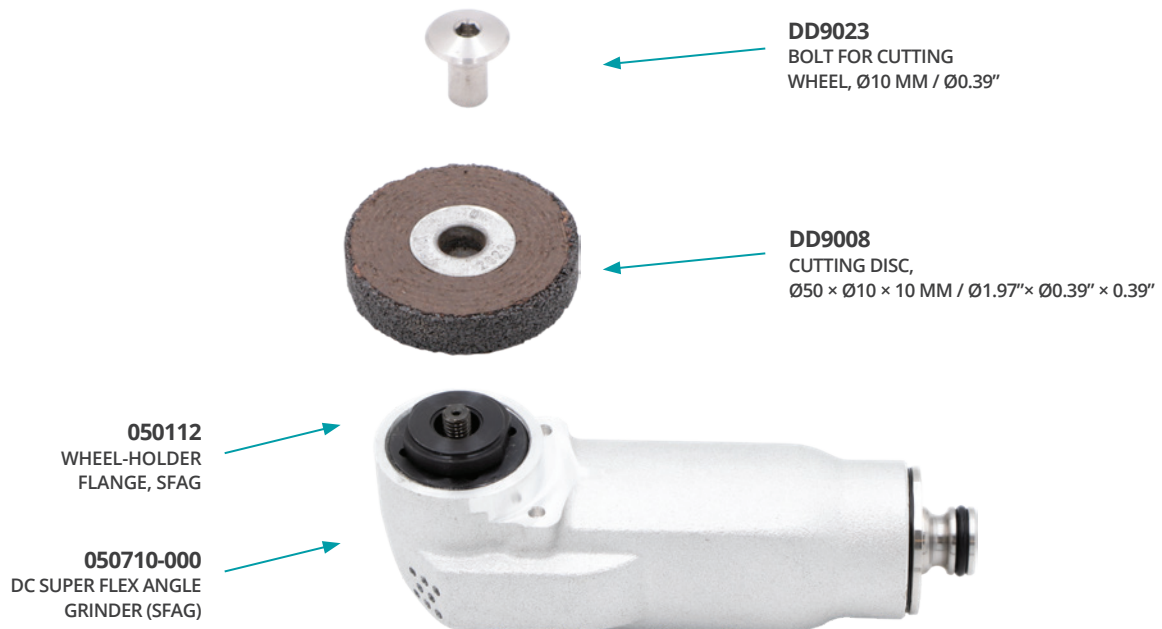

9.4 Attachment Instructions for Cutting Tools

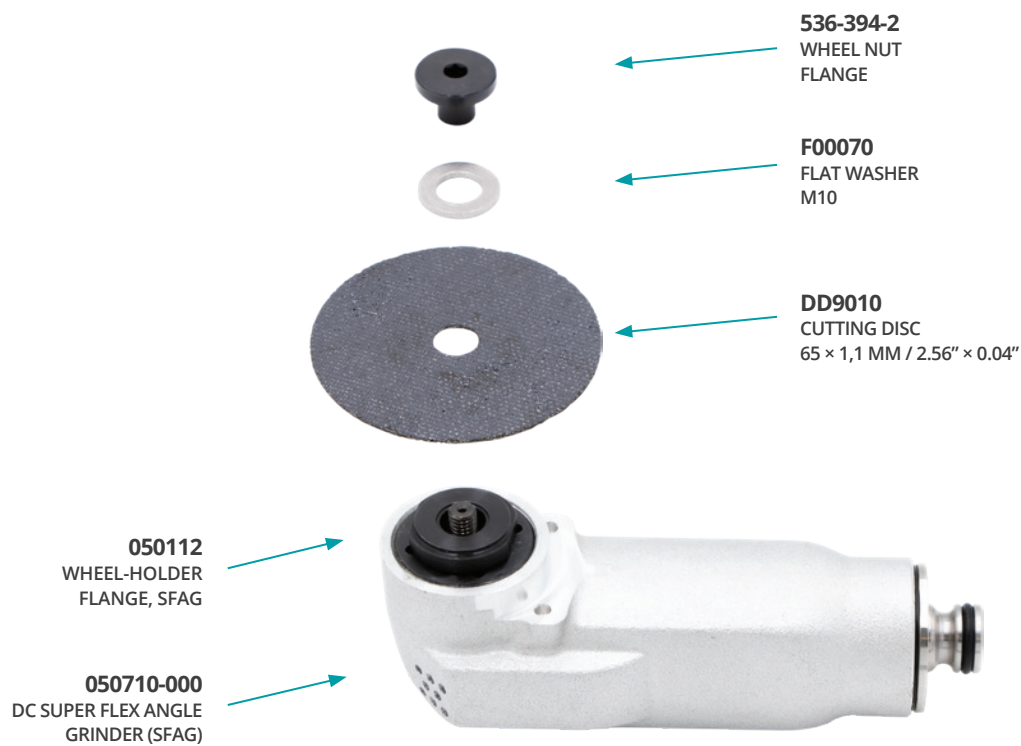

9.4 Attachment Instructions for Cutting Tools

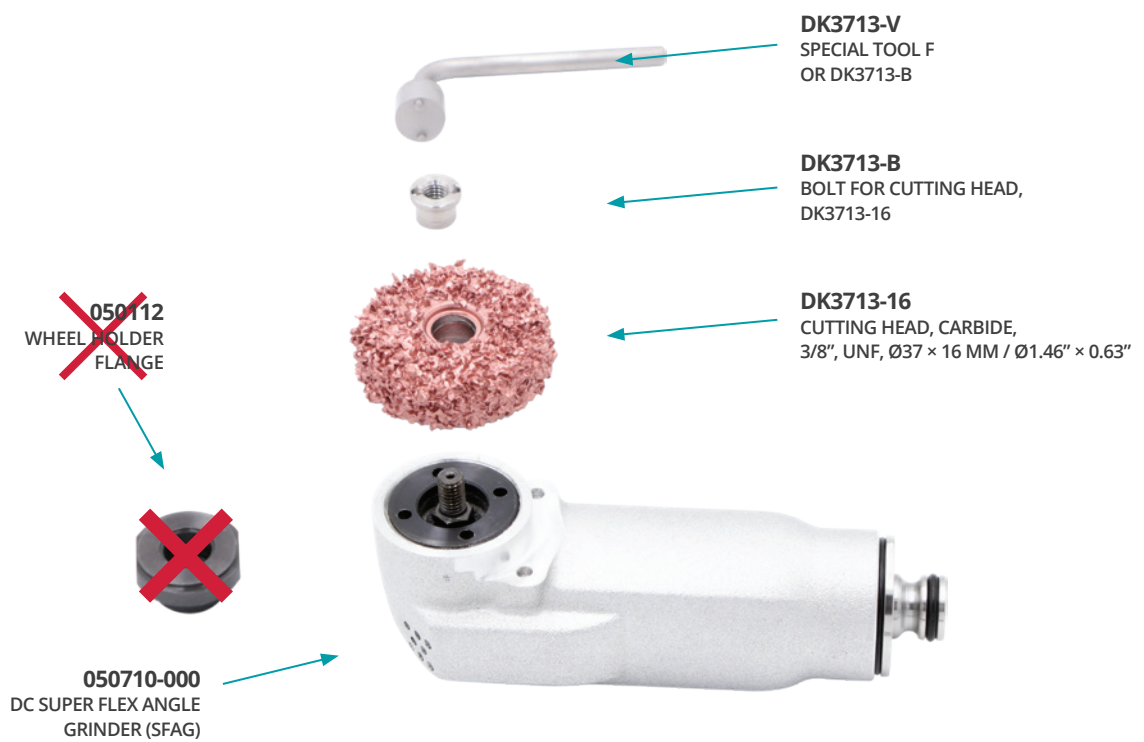

10.0 Quick Guide for FPV Headset

First-Time Setup:

- **Power On:** Turn the headset on by pressing the POWER button
- **Activate Control Unit:** Ensure that the control unit on the cutter is turned on
- **Signal Search:** Press and hold the SCAN button for 1-2 seconds while the headset locates the signal from the control unit
- **Fit Adjustment:** Adjust the Velcro straps on the headset for a comfortable fit
- **Charging the Battery:** Use the included micro USB cable to charge the headset battery



11.0 EU - Declaration of Conformity

Object of the declaration:

Product: Cutter equipment
Model/type: DC SUPER FLEX

This declaration is issued under the sole responsibility of the manufacturer.

The object of the declaration described above is in conformity with the relevant Union harmonisation legislation:

Directive 2006/42/EC of the European Parliament and of the Council of 17th Mai 2006
on the approximation of the Laws of the Member States Relating to Machinery.

Council Directive 2014/35/EU on the Harmonization of
The Laws of Member States Relating to Electrical Equipment Designed for
use within Certain Voltage Limits.

Council Directive 2014/30/EU on the Approximation of the
Laws of the Member States Relating to Electromagnetic Compatibility.

Conformity is shown by compliance with the applicable requirements of the following documents.

Reference and date	Title
EN ISO 12100:2011	Safety of machinery - General principles for design - Risk assessment and risk reduction.

Technical documentation is stored at the company address mentioned below:

Signed for and on behalf of: **Dancutter A/S**
Place of issue: DK-8800 Viborg
Name: Simon B. Hoffgaard
Position: General Manager

Signature:





A **Halma** company



Minicam Inc., 12600 Newburgh Road, Livonia, MI 48150, United States,
Phone: +1 (734) 744 5557, Email: sales@minicaminc.com

www.minicaminc.com